



# HPDE PERISTALTIC DISPENSER

MODEL  
HPDE1, 1H, 1P, 1HP  
HPDE2, 2H, 2P, 2HP

## Installation and Operation Instructions

2M-Z7245 Rev. K 2/13/13



HPDE2



## SAFETY SYMBOL



These symbols are intended to alert the user to the presence of important operating and maintenance instructions in the manual accompanying the appliance.

---

### RETAIN THIS MANUAL FOR FUTURE REFERENCE NOTICE

Using any part other than genuine Star factory supplied parts relieves the manufacturer of all liability.

Star reserves the right to change specifications and product design without notice. Such revisions do not entitle the buyer to corresponding changes, improvements, additions or replacements for previously purchased equipment.

Due to periodic changes in designs, methods, procedures, policies and regulations, the specifications contained in this sheet are subject to change without notice. While Star International Holdings Inc., Company exercises good faith efforts to provide information that is accurate, we are not responsible for errors or omissions in information provided or conclusions reached as a result of using the specifications. By using the information provided, the user assumes all risks in connection with such use.

## MAINTENANCE AND REPAIRS

Contact your local authorized service agent for service or required maintenance.

Please record the model number, serial number, voltage and purchase date in the area below and have it ready when you call to ensure a faster service.

Model No. \_\_\_\_\_  
Serial No. \_\_\_\_\_  
Voltage \_\_\_\_\_  
Purchase Date \_\_\_\_\_

### Authorized Service Agent Listing

Reference the listing provided with the unit

OR

for an updated listing go to:

**Website:** [www.star-mfg.com](http://www.star-mfg.com)  
**E-mail** [Service@star-mfg.com](mailto:Service@star-mfg.com)

### Service Help Desk

**Business Hours:** 8:00 am to 4:30 p.m. Central Standard Time

**Telephone:** (314) 678-6303

**Fax:** (314) 781-2714

**E-mail** [Parts@star-mfg.com](mailto:Parts@star-mfg.com)  
[Service@star-mfg.com](mailto:Service@star-mfg.com)  
[Warranty@star-mfg.com](mailto:Warranty@star-mfg.com)

**Website:** [www.star-mfg.com](http://www.star-mfg.com)

**Mailing Address:** Star International Holdings Inc., Company  
10 Sunnen Drive  
St. Louis, MO 63143  
U.S.A

## SPECIFICATIONS

---

### HPDE1, HPDE1H, HPDE1P, HPDE1HP

Capacity: Two 6 pound bags (Two 2.7 KG Bags)  
Electrical: 120V, 60 hertz, single phase, 820 Watts; 7 amps  
230V, 50/60 hertz, single phase, 820 Watts; 3.5 amps  
Cord: 6 ft. length  
Plug: 120V - NEMA 5-15P  
230V - CEE7-7  
Dimensions: 9 7/16" W x 20 7/16" D x 26 13/16" H (23.97 W x 51.91 D x 68.10 H cm)  
Net Weight: 36 lbs. (16.34 KG)

---

### HPDE2, HPDE2H, HPDE2P, HPDE2HP

Capacity: Four 6 pound bags (Four 2.7 KG Bags)  
Electrical: 120V, 60 hertz, single phase, 1000 Watts; 8.5 amps  
230V, 50/60 hertz, single phase, 1000 Watts; 4.5 amps  
Cord: 6 ft. length  
Plug: 120V - NEMA 5-15P  
230V - CEE7-7  
Dimensions: 14 5/16" W x 20 7/16" D x 26 13/16" H (36.35 W x 51.91 D x 68.10 H cm)  
Net Weight: 50 lbs. (22.7 KG)

---



This commercial foodservice dispenser is suitable for self-service applications solely for the purpose of dispensing the food product contained within the dispenser, provided the owner and operator maintain the food product at a safe temperature and condition and provide any necessary utensils, trays, or other apparatus in a safe and convenient location with appropriate instructions. This appliance is not intended for repair, cleaning, maintenance, loading and unloading of food product, or other uses by non-trained employees or the general public. This unit is not sold for consumer use in and around the home.

### -IMPORTANT-

**Read this manual completely before attempting installation.**

### INSTALLATION

This peristaltic dispenser is equipped for the voltage and wattage indicated on the nameplate mounted on the back of the unit, and is designed for use on alternating current (AC) only.

**DO NOT CONNECT TO DIRECT CURRENT (DC).**



### GENERAL OPERATING INSTRUCTIONS

This heated dispenser is designed to be used with a 9" x 18" (22.8 x 45.7cm) poly bag with a 1 inch (2.5cm) outlet fitment. The peristaltic dispenser is designed to be used with 1/4 inch ID (.6cm) to 1/2 inch id. (1.3cm) tubing with 1/16 inch (.16cm) wall thickness.

The dispenser is designed with an adjustable thermostat. It is designed to maintain a product temperature in the range of 145°F to 162°F (60°C to 72°C).

## Loading Product:

1. Turn the dispenser OFF.
2. Unhook the tension spring from the catch.
3. Slide the pump block away from the pump head.
4. Insert the new bag into tray making sure the fitment rests on the block track and route the tube around the rollers. *(Note: Make sure the tube is not twisted)*
5. Place the end of the tube in the slot of the bottom bracket.
6. Slide the pump block towards the pump head.
7. Hook the tension spring onto the catch.
8. Route the tube through the hole in the tube cover leaving 1/2" of the tube below the cover.
9. Dispense a small amount of product to insure the tube is seated correctly, and the product is flowing.

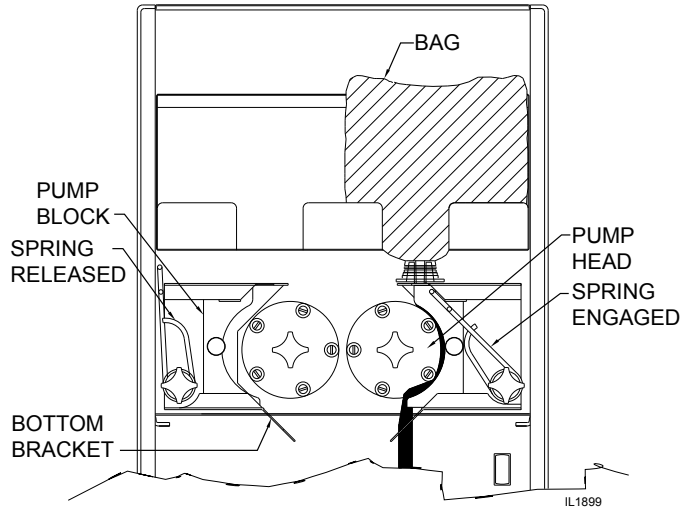

## PORTION CONTROL

This dispenser may be supplied with a portion control timer. This portion control is based on a time setting. Variations in product temperature and consistency will affect the dispensed amount. To insure a consistent portion, use product that is at the correct temperature, 145°F to 160° (62°C to 71°C).

## To set portion:

1. Load preheated product bag into dispenser.
2. Dispense product until there is a steady flow.
3. Dispense the product into a clean container, and measure the product to verify the dispensed amount.
4. Using a small screwdriver, turn the control dial located on the back panel clockwise for more product and counterclockwise for less product.
5. Repeat steps 3 and 4 until the desired amount is reached.

## Operation Notes:

The dispenser is a holding cabinet not a warmer. It is intended to hold the food product at no less than 140°F (60°C) and no more than 165°F (73°C) after the food product has been pre-heated to a minimum of 140°F (60°C).

The product should be preheated according to the manufacturer's instructions. The product should be a minimum of 140°F (60°C) before dispensing.

If the product is not preheated, you can expect it take 3 hours for the product to reach 140°F (60°C) if it starts out at room temperature. 5 Hours if it is refrigerated, and much longer if frozen.

The digital temperature readout displays the cabinet air temperature and will fluctuate during normal operation. The product temperature should be close to the temperature setpoint, but the actual product temperature should be checked periodically to ensure proper operation.

## CHECKING PRODUCT TEMPERATURE

If the product has not been pre-heated, it will take at 3-5 hours before it will reach 140° (60°C).

1. Dispense at least 3 inches of product into an insulated cup.
2. Without hesitation, insert the thermometer to the bottom of the cup and stir the product gently with the stem of the thermometer.
3. Position the tip of the thermometer in the center of the product mass.
4. The temperature should read between 140°F (60°C) and 165°F (73°C).

## CHANGING FACTORY TEMP PRESET

The dispenser is preset at the factory for a temperature of 150°F (65°C). If a different temperature is required, the setpoint can be changed in a range from 145°F to 162°F (60°C to 72°C).

To change the temperature:

1. Press and hold the SET button for 3 seconds until the display flashes.
2. Using the UP or DOWN buttons, set the temperature to the desired value.
3. Press the SET button to exit the programming mode.

The dispenser is designed to operate 24 hours a day. Once the product is placed in the dispenser it should not be removed until the bag is empty, or the holding period of the product has expired.

**NOTE: To increase the evacuation, open the dispenser and pull the product towards the bottom of the bag and the outlet fitment once or twice during operation.**

If the pump drips, or does not dispense product, check to make sure the tube is routed correctly, the spring is latched onto the catch.

**NOTE: The tube cover must be in place for proper operation.**

## CLEANING INSTRUCTIONS

### To clean the peristaltic dispenser:

The stainless steel body is corrosion resistant, but may corrode if not cleaned properly. The dispenser should be cleaned with a soft cloth with mild soap and water and wiped dry. Do not use detergents, strong abrasives, or metal scouring pads on the stainless steel panels.

The pump mechanism should not need cleaning during normal use. If product should spill onto the pump head, it can be removed for easy cleaning (*see Removal & Cleaning Pump Head*). Clean the parts in a solution of mild soap and water using a soft cloth. Dry parts before reassembling.

The spring can also be removed for cleaning by removing the knob and retaining washer.

### To remove and clean the pump head:

1. Open the door.
2. Remove the bag according to the instructions.
3. Unscrew the knob from the pump head.
4. Remove the pump head.
5. Slide the pump block out of the track.
6. If needed the rollers can also be disassembled for cleaning.

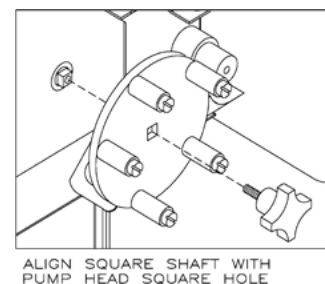
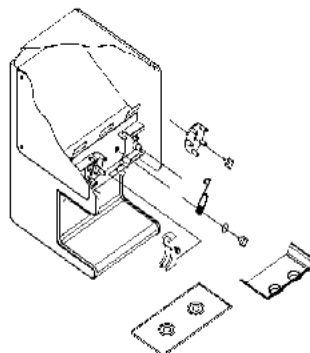

Note: When installing the pump head onto the drive shaft, make sure the pump head is fully seated onto the square end of the drive shaft before installing the knob.

**WARNING: The drive shaft and pump head could be damaged if the pump head is installed incorrectly.**

### THOROUGHLY INSPECT YOUR UNIT ON ARRIVAL

This unit has been tested for proper operation before leaving our plant to insure delivery of your unit in perfect condition. However, there are instances in which the unit may be damaged in transit. In the event you discover any type of damage to your product upon receipt, you must immediately contact the transportation company who delivered the item to you and initiate your claim with same. If this procedure is not followed, it may affect the warranty status of the unit.

### LIMITED EQUIPMENT WARRANTY

All workmanship and material in Star products have a one (1) year limited warranty on parts & labor in the United States and Canada. Such warranty is limited to the original purchaser only and shall be effective from the date the equipment is placed in service. Star's obligation under this warranty is limited to the repair of defects without charge, by the factory authorized service agency or one of its sub-agencies. Models that are considered portable (*see below*) should be taken to the closest Star service agency, transportation prepaid.

- > Star will not assume any responsibility for loss of revenue.
- > On all shipments outside the United States and Canada, see International Warranty.
- \* The warranty period for the Ultra-Max, Hot Plates, Griddles, Charbroilers is (3) years parts & labor.
- \* The warranty period for the Star-Max, Charbroilers, Griddles, Hot Plates, Fryers & Finishing Oven is (2) years parts & labor.
- \* The warranty period for the JetStar six (6) ounce & Super JetStar eight (8) ounce series popcorn machines is two (2) years.
- \* The warranty period for the Chrome-Max Griddles is five (5) years on the griddle surface. See detailed warranty provided with unit.
- \* The warranty period for Teflon/Dura-Tec coatings is one year under normal use and reasonable care. This warranty does not apply if damage occurs to Teflon/Dura-Tec coatings from improper cleaning, maintenance, use of metallic utensils, or abrasive cleaners, abrasive pads, product identifiers and point-of-sale attachments, or any other non-food object that comes in continuous contact with the roller coating. This warranty does not apply to the "non-stick" properties of such materials.
- > This warranty does not apply to "Special Products" but to regular catalog items only. Star's warranty on "Special Products" is six (6) months on parts and ninety (90) days on labor.
- > This warranty does not apply to any item that is disassembled or tampered with for any purpose other than repair by a Star Authorized Service Center or the Service Center's sub-agency.
- > This warranty does not apply if damage occurs from improper installation, misuse, wrong voltage, wrong gas or operated contrary to the Installation and Operating instructions.
- > This warranty is not valid on Conveyor Ovens *unless* a "start-up/check-out" has been performed by a Factory Authorized Technician.

### PARTS WARRANTY

Parts that are sold to repair out of warranty equipment are warranted for ninety (90) days. The part only is warranted, the labor to replace the part is **NOT** warranted.

### SERVICES NOT COVERED BY WARRANTY

1. Travel time and mileage rendered beyond the 50 mile radius limit
2. Mileage and travel time on portable equipment (*see below*)
3. Labor to replace such items that can be replaced easily during a daily cleaning routine, ie; removable kettles on fryers, knobs, grease drawers on griddles, etc.
4. Installation of equipment
5. Damages due to improper installation
6. Damages from abuse or misuse
7. Operated contrary to the Operating and Installation Instructions
8. Cleaning of equipment
9. Seasoning of griddle plates
10. Voltage conversions
11. Gas conversions
12. Pilot light adjustment
13. Miscellaneous adjustments
14. Thermostat calibration and by-pass adjustment
15. Resetting of circuit breakers or safety controls or reset buttons
16. Replacement of bulbs
17. Replacement of fuses
18. Repair of damage created during transit, delivery, & installation OR created by acts of God

### PORTABLE EQUIPMENT

Star will not honor service bills that include travel time and mileage charges for servicing any products considered "Portable" including items listed below. These products should be taken to the Service Agency for repair:

- \* The Model 510FD, 510FF Fryer.
- \* The Model 526TOA Toaster Oven.
- \* The Model J4R, 4 oz. Popcorn Machine.
- \* The Model 518CMA & 526CMA Cheese Melter.
- \* The Model 12MC & 15MC & 18MCP Hot Food Merchandisers.
- \* The Model 12NCPW & 15NCPW Nacho Chip/Popcorn Warmer.
- \* All Hot Dog Equipment **except Roller Grills & Drawer Bun Warmers.**
- \* All Nacho Cheese Warmers **except Model 11WLA Series Nacho Cheese Warmer.**
- \* All Condiment Dispensers **except the Model HPD & SPD Series Dispenser.**
- \* All Specialty Food Warmers **except Model 130R, 11RW Series, and 11WSA Series.**
- \* All QCS/RCS Series Toasters **except Model QCS3 & RCS3 Series.**
- \* All Fast Steamer Models **except Direct Connect Series.**

### ALL:

- \* Pop-Up Toasters
- \* Butter Dispensers
- \* Pretzel Merchandisers  
(Model 16PD-A Only)
- \* Pastry Display Cabinets
- \* Nacho Chip Merchandisers
- \* Accessories of any kind
- \* Sneeze Guards
- \* Pizza Ovens  
(Model PO12 Only)
- \* Heat Lamps
- \* Pumps-Manual

The foregoing warranty is in lieu of any and all other warranties expressed or implied and constitutes the entire warranty.

### FOR ASSISTANCE

Should you need any assistance regarding the Operation or Maintenance of any Star equipment; write, phone, fax or email our Service Department. In all correspondence mention the Model number and the Serial number of your unit, and the voltage or type of gas you are using.

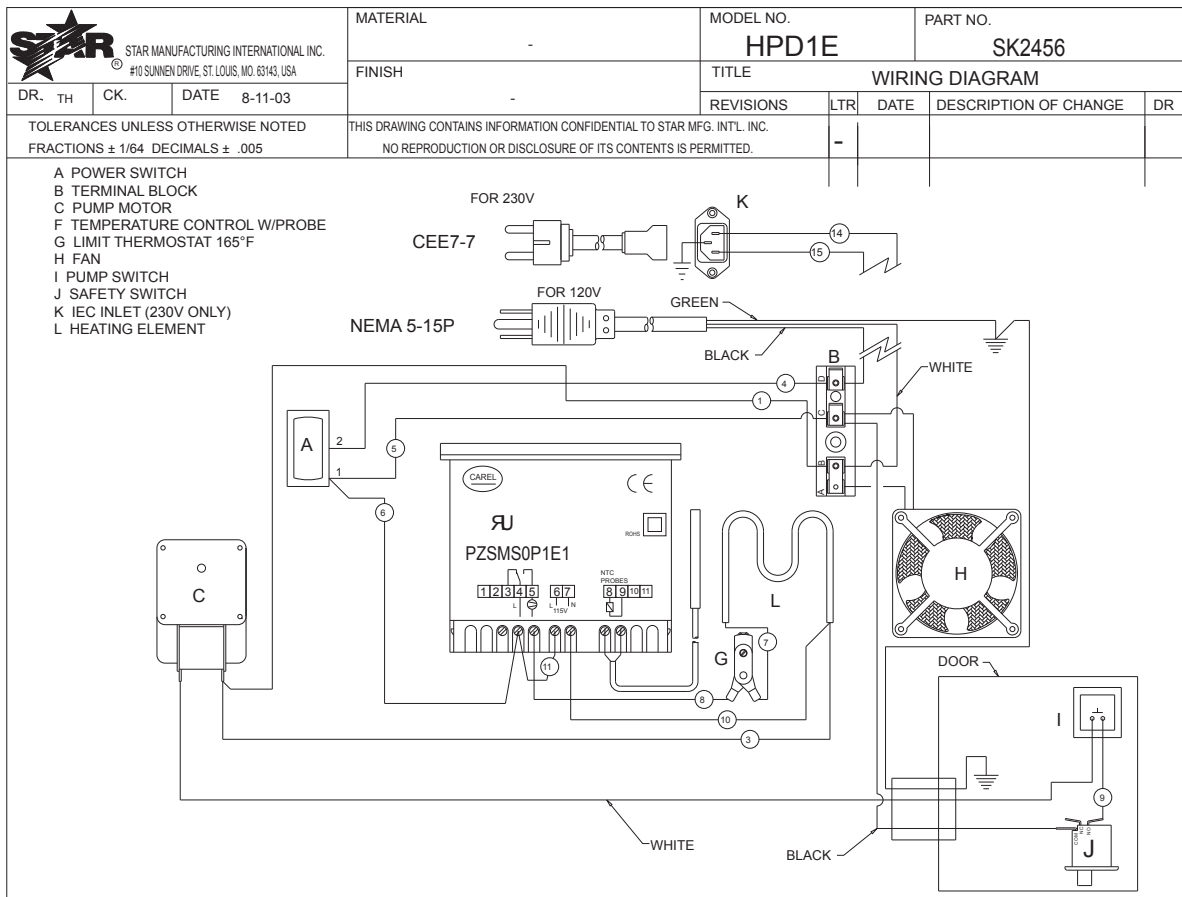
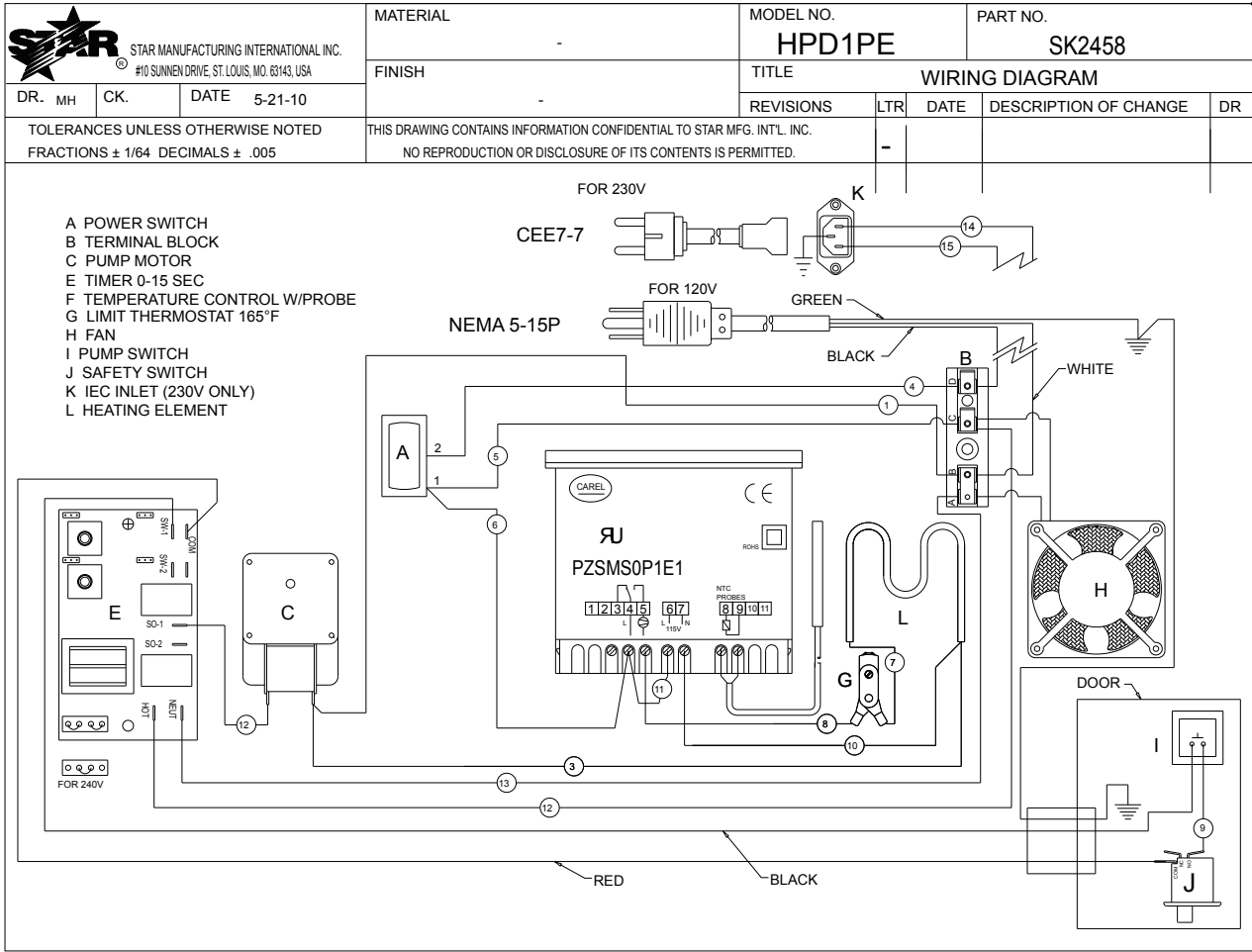

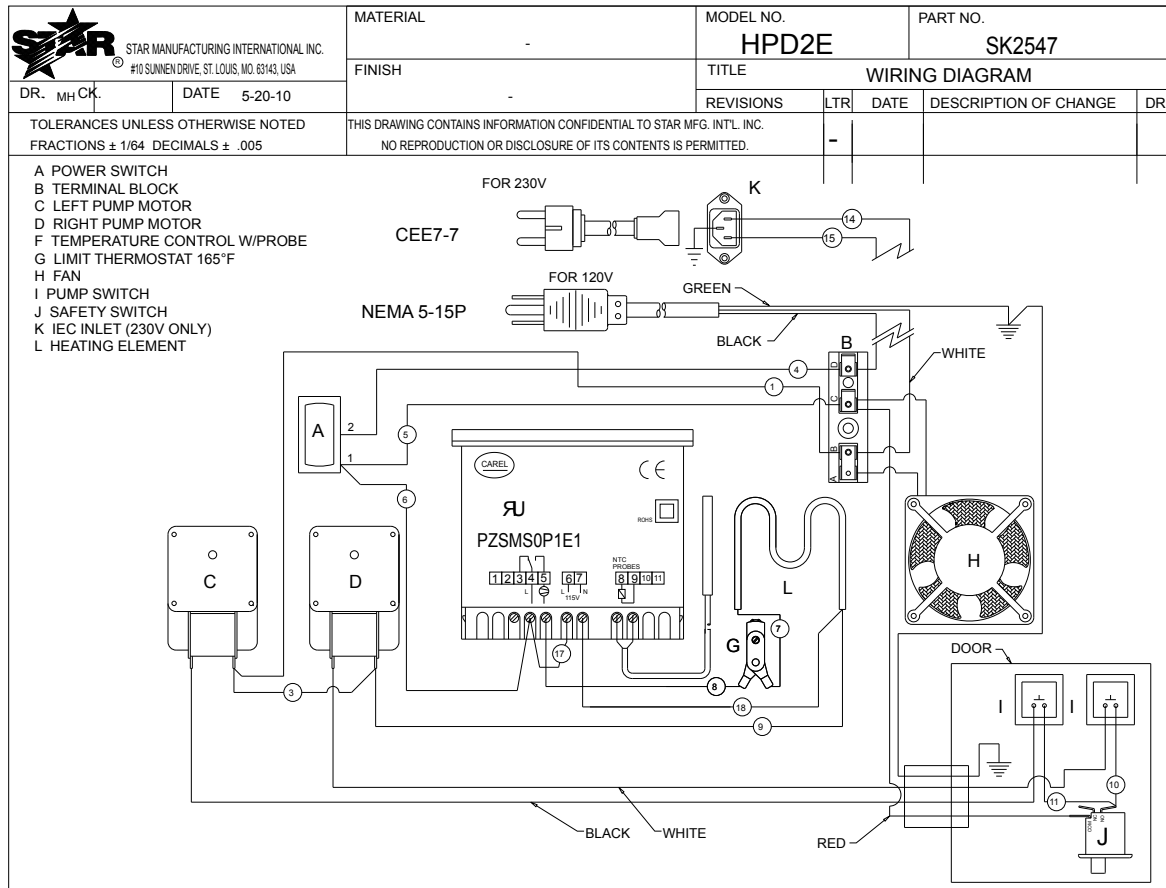
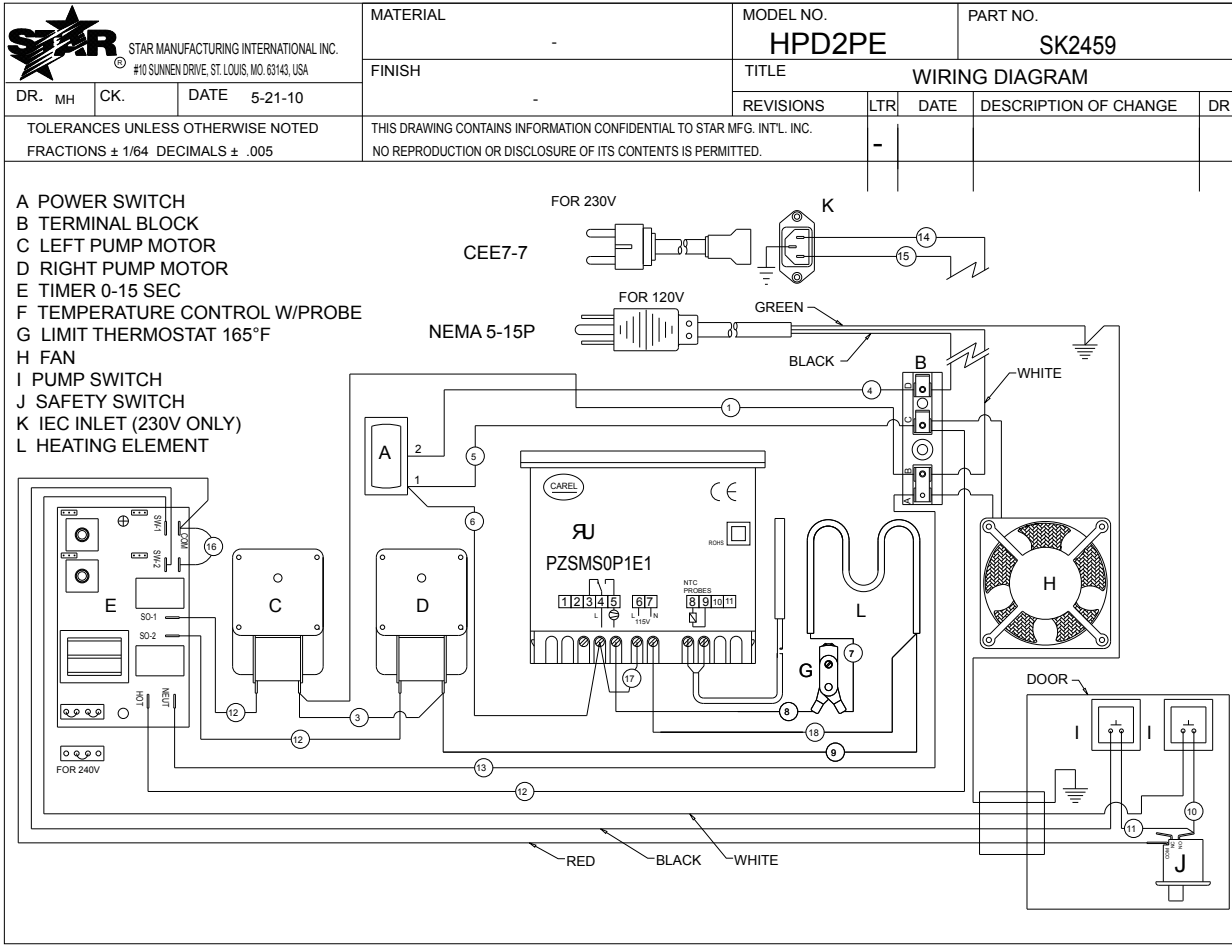





STAR MANUFACTURING INTERNATIONAL, INC.  
 #10 SUNNEN DRIVE, ST. LOUIS, MO. 63143, USA

DR. MH	C.K.	DATE	5-21-10
--------	------	------	---------

TOLERANCES UNLESS OTHERWISE NOTED  
 FRACTIONS ± 1/64 DECIMALS ± .005

MATERIAL

FINISH

MODEL NO.

HPDE1SHP

PART NO.

SK2460

TITLE

WIRING DIAGRAM HPDE1SHP

REVISIONS	LTR	DATE	DESCRIPTION OF CHANGE	DR
-	-	-	-	-

THIS DRAWING CONTAINS INFORMATION CONFIDENTIAL TO STAR MFG. INT'L. INC.  
 NO REPRODUCTION OR DISCLOSURE OF ITS CONTENTS IS PERMITTED.

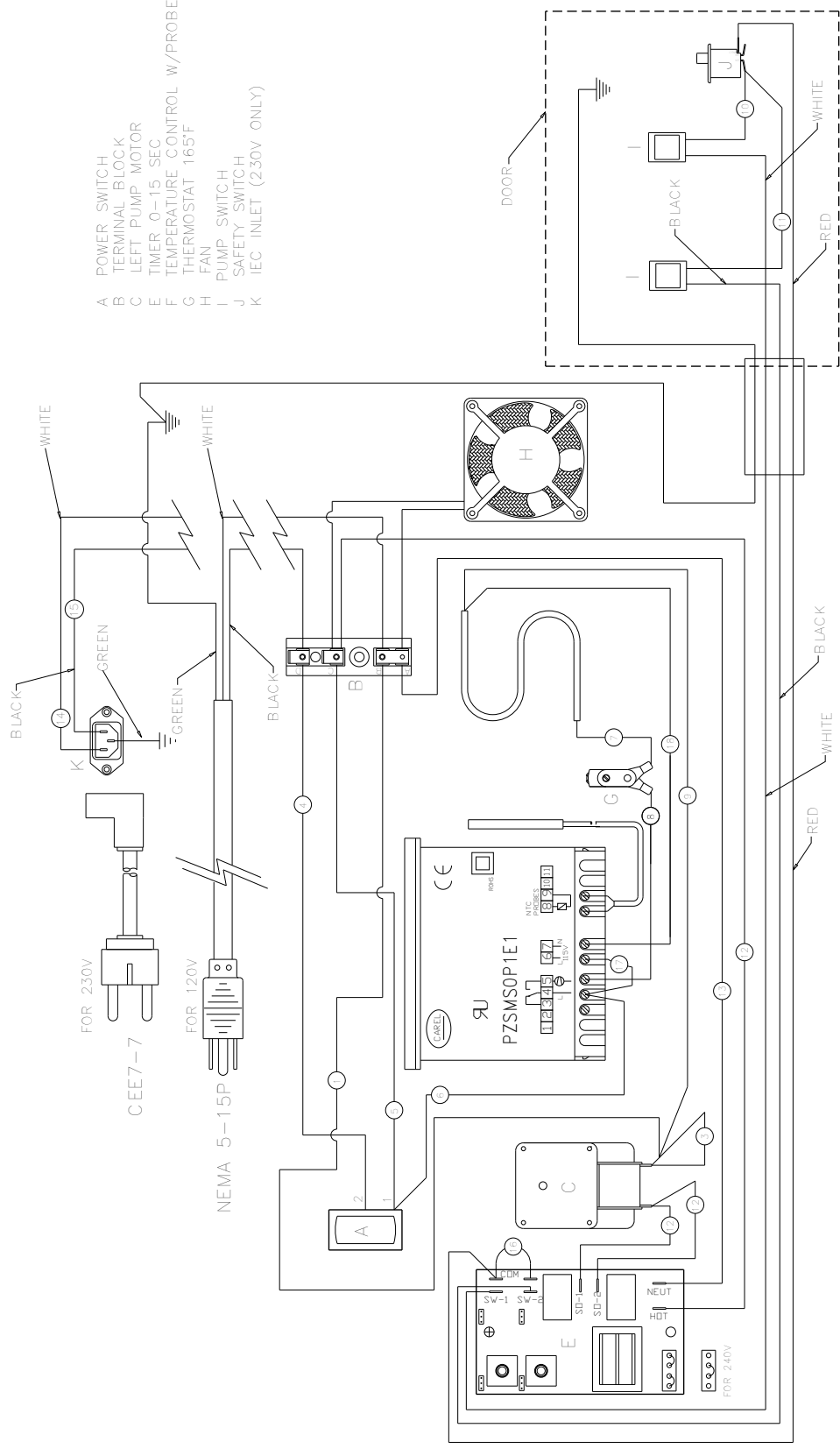

- A POWER SWITCH
- B TERMINAL BLOCK
- C LEFT PUMP MOTOR
- E TIMER 0-15 SEC
- F TEMPERATURE CONTROL W/PROBE
- G THERMOSTAT 165°F
- H FAN
- I PUMP SWITCH
- J SAFETY SWITCH
- K IEC INLET (230V ONLY)

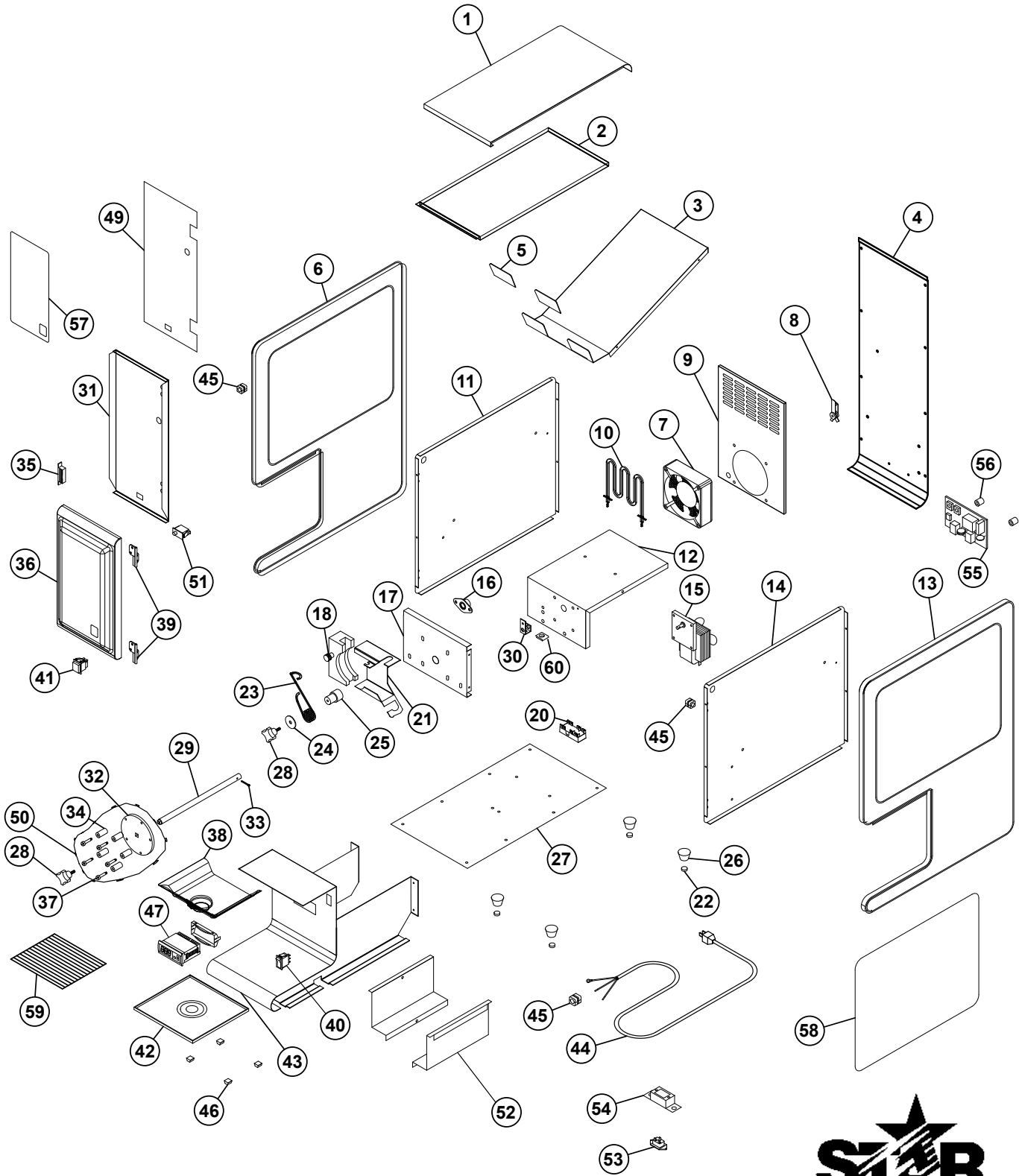

MODELS: HPD1E, HPD1PE,  
HPD1HE, HPD1HPE



STAR MANUFACTURING INTERNATIONAL, INC.

SK2008

Rev. A

10/17/06

# PARTS LIST

February 13, 2013, Rev. L

MODEL: HPDE1 Series Heated Peristaltic Dispenser

Key Number	Part Number	Number Per Unit	Description and Model Designation
1	M2-Z4641	1	TOP
2	M2-Z4668	1	TOP LINER
3	M2-Z4634	1	BAG TRAY
4	M2-Z4655	1	BACK
	M2-Z5804	1	BACK
	M2-Z4656	1	BACK
5	2I-Z4663	1	VINYL CAP 1 9/16 x 2 5/8
6	2L-Z4591	1	LEFT SIDE PANEL
7	2U-200559	1	MOTOR, FAN 120V 12A12-BTM
	2U-Z5041	1	FAN A/C 110CFM 230V
8	2T-Z4666	1	HI-LIMIT THERMOSTAT 165°F
9	M2-PD1017	1	FAN WALL ASSEMBLY
10	2N-Z4603	1	ELEMENT 120V / 650W
	2N-Z5044	1	ELEMENT 230V/650W
11	M2-Z4636	1	LINER LEFT
12	M2-Z7241	1	WALL-MOTOR
13	2L-Z4592	1	RIGHT SIDE PANEL
14	M2-Z4637	1	LINER RIGHT
15	PS-Z10009	1	MOTOR 165RPM COUNTER-CLOCKWISE
	PS-Z10013	1	MOTOR CCW 165 RPM 230V
	PS-Z10007	1	MOTOR 75 RPM CCW
	PS-Z10011	1	MOTOR 75 RPM CCW 230V
	PS-Z10009	1	MOTOR 120 RPM CCW
16	2P-9615	1	BEARING SELF ALIGN .51 ID
17	M2-PD1004	1	PUMP WALL ASSEMBLY
18	M2-Z2049	1	ASSEMBLY BLOCK RIGHT
19	2I-Y6709	1	CUSHION-MOTOR
20	2E-Z4597	1	TERMINAL BLOCK 1/4 P.O.
21	M2-PD2006	1	TRACK LEFT ASSEMBLY
22	2P-9564	4	PLUG-RUBBER
23	2P-Z4598	1	SPRING LEFT
24	2C-Z1689	1	WASHER 1.25 O.D. x 9/32 ID
25	2A-Z1616	1	BUSHING
26	2I-Z0057	4	FOOT
27	M2-Z4672	1	BOTTOM
	M2-Z5050	1	BOTTOM 230V
28	2R-Z6774	2	KNOB-DAVIES 4200 10-24 x 1/4
29	2A-Z4595	1	DRIVE SHAFT
30	M2-Z7236	1	BRACKET - PROBE
31	M2-PD1016	1	DOOR ASSEMBLY, INNER DOOR LINER
32	2V-Z1619	1	PUMP HEAD
33	2C-Z11912	1	HAIR PIN .091 DIA X 1.625
34	2A-Z1621	5	ROLLER #10 x 1-1/2 x 1 NYLON
35	2C-9788	1	MAGNETIC CATCH 9LB
36	2L-Z4858	1	DOOR, OUTER
	M2-Z5803	1	DOOR, OUTER
37	2C-Z1620	5	SHOULDER SCREW #8-32 x 1/4
38	2L-Z4659	1	TUBE COVER
39	2R-Z4893	2	HINGE SET
40	PS-PD2046	1	SWITCH ON/OFF (LIGHTED REPLACEMENT)
	2E-Z0091	1	SWITCH ON/OFF (non-lighted)
41	2E-Z1622	1	SWITCH MOMENTARY
42	M2-Z4631	1	DRIP TRAY
	M2-Z5617	1	DRIP TRAY CE
43	M2-PD1015	1	BODY FRONT ASSEMBLY

**IMPORTANT: WHEN ORDERING, SPECIFY VOLTAGE OR TYPE GAS DESIRED  
INCLUDE MODEL AND SERIAL NUMBER**

PAGE 1  
OF 2

Some items are included for illustrative purposes only and in certain instances may not be available.



**Star International Holdings, Inc. Company**

# PARTS LIST

February 13, 2013, Rev. L

MODEL HPDE1 Series Heated Peristaltic Dispenser

Key Number	Part Number	Number Per Unit	Description and Model Designation
44	A3-ST3006	1	CORDSET ASSEMBLY HPDE1
	2E-Z0512	1	CORDSET 230V HPDE1
45	2K-7889	1	BUSHING HEYCO SR-11-2 HPDE1
46	2A-H7804	4	BUMP-ON RUBBER SQ
47	M2-Z11877	1	CONTROL SET TO 150°F, w/PROBE 120V
	2E-Z13212	1	TEMPERATURE CONTROL 230V (does not include probe)
	2E-Z13215	1	PROBE NTC
	M2-Z11877	1	CONTROL - SET TO 150°F HPDE1BE-120V
49	2M-Z13395	1	LABEL-DOOR INTERIOR
50	M2-22017	1	PUMP HEAD ASSEMBLY
51	2E-Z1684	1	SWITCH-SPDT
52	M2-Z5031	2	LINER-LOWER
53	2E-Z3034	1	I.E.C. INLET
54	A3-Z4357	1	INLET HOUSING
55	M2-Z10302	1	TIMER 0-15 SEC 120V
	M2-Z5791	1	TIMER 0-15 SEC 230V
56	2A-Z3429	2	SPACER-NYLON .175 x .375 x .5
57	2M-Z4604	1	LABEL - DOOR STAR
	2M-Z5010	1	LABEL - DOOR NESTLE
	2M-Z5014	1	LABEL - FRONT RICOS
	2M-Z5610	1	LABEL - FRONT CLASSIC FOODS
	2M-Z5613	1	LABEL - FRONT CLASSIC FOODS GRAVY
	2M-Z5805	1	LABEL - DOOR HDPE1SHP
	2M-Z6475	1	LABEL - FRONT RICOS CHILI
	2M-Z11872	1	LABEL - HPD1 FRNT BOB EVAN HPDEBE-120V
58	2M-Z5011	2	LABEL - SIDE PANEL NESTLE
	2M-Z5015	2	LABEL - SIDE RICOS
	2M-Z5611	2	LABEL - SIDE CLASSIC FOODS
	2M-Z5614	2	LABEL - SIDE CLASSIC FOODS GRAVY
	2M-Z6476	1	LABEL - SIDE PANEL RICOS CHILI
59	2B-Z5616	1	GRATE HPDE1CF
60	2C-Z3700	1	CLIP - PROBE

**IMPORTANT: WHEN ORDERING, SPECIFY VOLTAGE OR TYPE GAS DESIRED  
INCLUDE MODEL AND SERIAL NUMBER**

PAGE 2  
OF 2

Some items are included for illustrative purposes only and in certain instances may not be available.

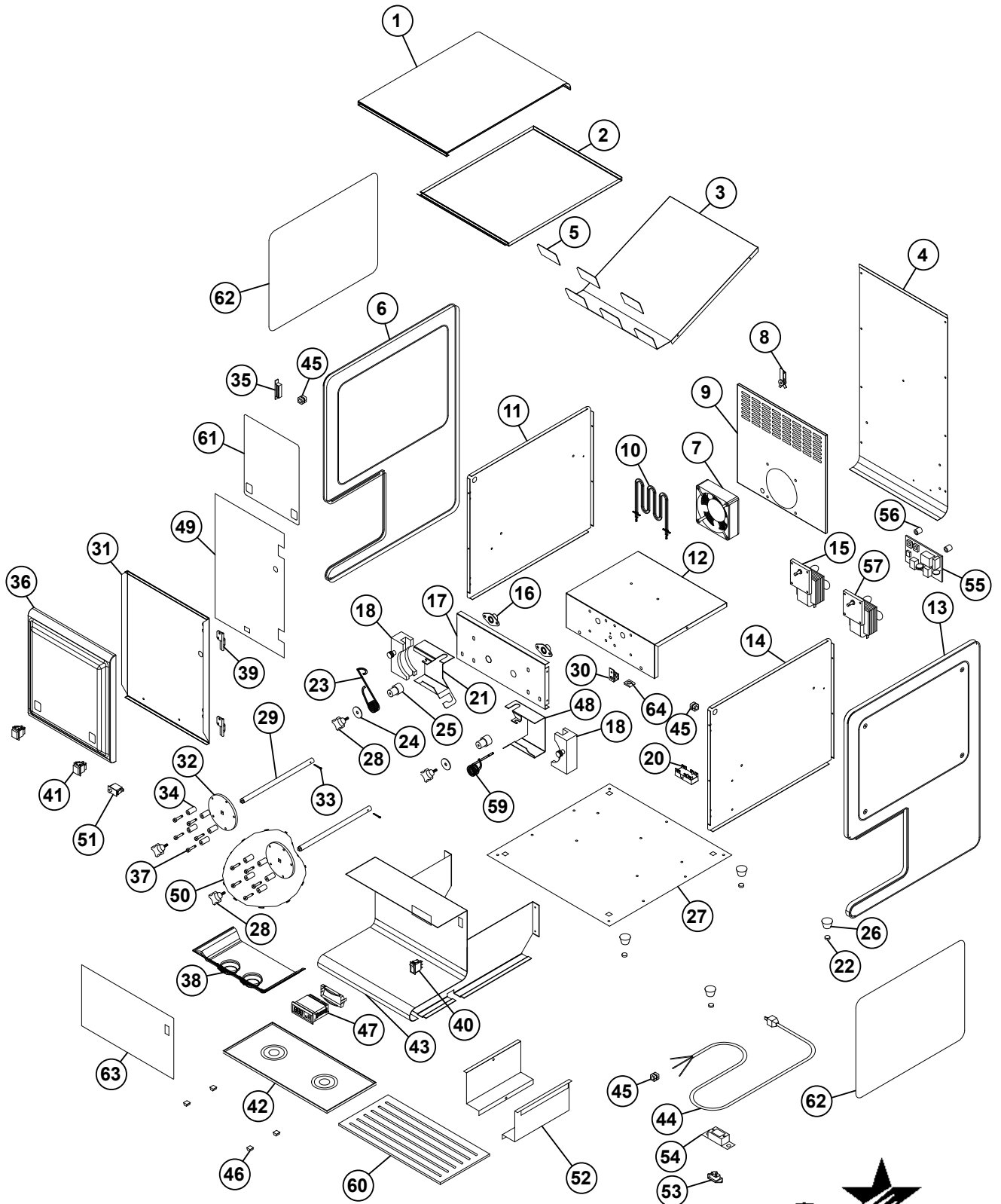

MODELS HPD2E, HPD2PE,  
HPD2HE, HPD2HPE, HPD2BLE

STAR MANUFACTURING INTERNATIONAL, INC.  
SK2009 Rev. C 11-11-11

# PARTS LIST

February 13, 2013, Rev. L

## MODEL HPDE2 Series Heated Peristaltic Dispenser

Key Number	Part Number	Number Per Unit	Description and Model Designation
1	M2-Z4640	1	TOP
	M2-Z5794	1	TOP HPDE2BL
2	M2-Z4667	1	TOP LINER
3	M2-Z4635	1	BAG TRAY
4	M2-Z4626	1	BACK HPDE2P
	M2-Z4627	1	BACK HPDE2
	M2-Z5795	1	BACK HPDE2BL
5	2I-Z4662	3	VINYL CAP 1 9/16 x 2 3/4
6	2L-Z4591	1	LEFT SIDE PANEL
7	2U-200559	1	MOTOR, FAN 120V 12A12-BTM 120V
	2U-Z5041	1	FAN A/C 110CFM 230V 230V
8	2T-Z4666	1	HI-LIMIT THERMOSTAT 165°F
9	M2-PD2027	1	FAN WALL ASSEMBLY
10	2N-Z4603	1	ELEMENT 120V/650W
	2N-Z5044	1	ELEMENT 230V/650W
11	M2-Z4636	2	LINER LEFT
12	M2-Z7234	1	WALL-MOTOR
13	2L-Z4592	1	RIGHT SIDE PANEL
14	M2-Z4637	1	LINER RIGHT
15	PS-Z10009	1	MOTOR 165 RPM COUNTERCLOCKWISE HPDE2H
	PS-Z10013	1	MOTOR CCW 165 RPM 230V
	PS-Z10007	1	MOTOR 75 RPM CCW
	PS-Z10011	1	MOTOR 75 RPM CCW 230V
16	2P-9615	2	BEARING SELF ALIGN .51 ID
17	M2-PD2004	1	PUMP WALL ASSEMBLY
18	M2-22121	2	ASSEMBLY BLOCK
20	2E-Z4597	1	TERMINAL BLOCK 1/4 P.O.
21	M2-PD2006	1	TRACK LEFT ASSEMBLY
22	2P-9564	4	PLUG-RUBBER
23	2P-Z4598	1	SPRING LEFT
24	2C-Z1689	2	WASHER 1.25 O.D. x 9/32 ID
25	2A-Z1616	2	BUSHING
26	2I-Z0057	4	FOOT
27	M2-Z4673	1	BOTTOM
	M2-Z5051	1	BOTTOM 230V
28	2R-Z6774	4	KNOB-DAVIES 4200 10-24 x 1/4
29	2A-Z4595	2	DRIVE SHAFT
30	M2-Z7236	1	BRACKET - PROBE
31	M2-PD2026	1	DOOR ASSEMBLY, INNER DOOR LINER
32	2V-Z1619	2	PUMP HEAD
33	2C-Z11912	2	HAIR PIN .091 DIA. X 1.625
34	2A-Z1621	10	ROLLER #10 x 1-1/2 x 1 NYLON
35	2C-9788	1	MAGNETIC CATCH 9LB
36	2L-Z4857	1	DOOR, OUTER
37	2C-Z1620	10	SHOULDER SCREW #8-32 x 1/4
38	2L-Z4658	1	TUBE COVER
39	2R-Z4893	2	HINGE SET

**IMPORTANT: WHEN ORDERING, SPECIFY VOLTAGE OR TYPE GAS DESIRED  
INCLUDE MODEL AND SERIAL NUMBER**

PAGE 1  
OF 2

Some items are included for illustrative purposes only and in certain instances may not be available.



**Star International Holdings, Inc. Company**

# PARTS LIST

February 13, 2013, Rev. L

MODEL \_\_\_\_\_ **HPDE2 Series Heated Peristaltic Dispenser**

Key Number	Part Number	Number Per Unit	Description and Model Designation
40	PS-PD2046	1	SWITCH ON/OFF (LIGHTED REPLACEMENT)
	2E-Z0091	1	SWITCH ON/OFF (NON-LIGHTED)
41	2E-Z1622	2	SWITCH MOMENTARY
42	M2-Z4630	1	DRIP TRAY
	M2-Z5030	1	DRIP TRAY - CLASSIC FOODS
	2L-Z5796	1	DRIP TRAY HPDE2BL
43	M2-PD2024	1	BODY FRONT ASSEMBLY
	M2-PD2025	1	BODY FRONT ASSEMBLY HPDE2BL
44	A3-ST3006	1	CORDSET ASSEMBLY
	2E-Z0512	1	CORDSET 230V
45	2K-7889	3	BUSHING HEYCO SR-11-2
46	2A-H7804	4	BUMP-ON RUBBER SQ
47	M2-Z11877	1	CONTROL SET TO 150°F, w/PROBE 120V
	2E-Z13215	1	PROBE NTC
	2E-Z13212	1	TEMPERATURE CONTROL 230V (does not include probe)
	2E-Z13215	1	PROBE NTC
48	M2-PD2005	1	TRACK RIGHT ASSEMBLY
49	2M-Z13394	1	LABEL-DOOR INTERIOR
50	M2-22017	2	PUMP HEAD ASSEMBLY
51	2E-Z1684	1	SWITCH-SPDT
52	M2-Z5031	2	LINER - LOWER
53	2E-Z3034	1	I.E.C. INLET 230V
54	A3-Z4357	1	INLET HOUSING 230V
55	M2-Z10302	1	TIMER 0-15 SEC 120V
	M2-Z5791	1	TIMER 0-15 SEC 230V
56	2A-Z3429	2	SPACER-NYLON .175 x .375 x .5
57	PS-Z10010	1	MOTOR 165 RPM CLOCKWISE HPDE2H
	PS-Z10014	1	MOTOR CW 165 RPM 230V
	PS-Z10008	1	MOTOR 75 RPM CW
	PS-Z10012	1	MOTOR 75 RPM CW 230V
59	2P-Z4599	1	SPRING RIGHT
60	2B-Z5029	1	GRATE - CLASSIC FOODS
61	2M-Z4605	1	LABEL - FRONT STAR
	2M-Z5012	1	LABEL - FRONT PANEL NESTLE
	2M-Z5018	1	LABEL - FRONT RICOS CHEESE
	2M-Z5019	1	LABEL - FRONT RICOS CHEESE/CHILI
	2M-Z5022	1	LABEL - FRONT CLASSIC FOODS
	2M-Z5024	1	LABEL - FRONT PANEL 7-ELEVEN
62	2M-Z5013	2	LABEL - SIDE PANEL
	2M-Z5015	2	LABEL - SIDE RICOS CHEESE
	2M-Z5620	1	LABEL - LEFT RICOS CHEESE/CHILI
	2M-Z5621	1	LABEL - RIGHT RICOS CHEESE/CHILI
	2M-Z5612	2	LABEL - SIDE CLASSIC FOODS
63	2M-Z7246	1	LABEL - BODY FRONT
64	2C-Z3700	1	CLIP - PROBE
65			

**IMPORTANT: WHEN ORDERING, SPECIFY VOLTAGE OR TYPE GAS DESIRED**

PAGE 2

**INCLUDE MODEL AND SERIAL NUMBER**

OF 2

Some items are included for illustrative purposes only and in certain instances may not be available.



**Star International Holdings, Inc. Company**

**STAR INTERNATIONAL HOLDINGS INC. COMPANY**

Star - Holman - Lang - Wells - Bloomfield - Toastmaster

10 Sunnen Drive, St. Louis, MO 63143 U.S.A.

(314) 678-6303

[www.star-mfg.com](http://www.star-mfg.com)